



TNT Fireworks  
768 E. Dania Beach Blvd.  
Dania Beach, Fl 33004  
(Tel) 954.920.6770  
(Fax)954.920-6878

City of Dania Beach Building Department  
100 West Dania Beach Blvd.  
Dania Beach, Florida 33004

To Whom It May Concern:

Neptune Fireworks will be holding our annual Firework Sales Beginning 6/5/15 through 7/13/15. We have hired Tents n Events to install temporary tents for the event.

I, Itzhak Dickstein give Tents N Events the authority to apply for all necessary permits needed for this event.

If you should require more information please contact me at 954-920-6770.

Thank you for your cooperation in this matter.

With regards,  
Itzhak Dickstein

A handwritten signature in black ink, appearing to be "Itzhak Dickstein", written over a horizontal line.



# CERTIFICATE OF LIABILITY INSURANCE

DATE (MM/DD/YYYY)  
11/7/2014

THIS CERTIFICATE IS ISSUED AS A MATTER OF INFORMATION ONLY AND CONFERS NO RIGHTS UPON THE CERTIFICATE HOLDER. THIS CERTIFICATE DOES NOT AFFIRMATIVELY OR NEGATIVELY AMEND, EXTEND OR ALTER THE COVERAGE AFFORDED BY THE POLICIES BELOW. THIS CERTIFICATE OF INSURANCE DOES NOT CONSTITUTE A CONTRACT BETWEEN THE ISSUING INSURER(S), AUTHORIZED REPRESENTATIVE OR PRODUCER, AND THE CERTIFICATE HOLDER.

**IMPORTANT:** If the certificate holder is an ADDITIONAL INSURED, the policy(ies) must be endorsed. If SUBROGATION IS WAIVED, subject to the terms and conditions of the policy, certain policies may require an endorsement. A statement on this certificate does not confer rights to the certificate holder in lieu of such endorsement(s).

<b>PRODUCER</b> BB Insurance Marketing Inc 11870 W. State Road 84, C-15 Ft. Lauderdale FL 33324	<b>CONTACT NAME:</b> Lindsy Gainey ext 311 <b>PHONE (A/C, No, Ext):</b> 954-452-4900 <b>E-MAIL ADDRESS:</b> lindsy@bbimi.com	<b>FAX (A/C, No):</b> 954-452-0450
	<b>INSURER(S) AFFORDING COVERAGE</b>	
<b>INSURED</b> TENTS-1  Tents N Events, Inc. 1790 Mears Parkway Margate FL 33063	<b>INSURER A:</b> New York Marine and  <b>INSURER B:</b>  <b>INSURER C:</b>  <b>INSURER D:</b>  <b>INSURER E:</b>  <b>INSURER F:</b>	<b>NAIC #</b>

**COVERAGES**                      **CERTIFICATE NUMBER:** 1274802431                      **REVISION NUMBER:**

THIS IS TO CERTIFY THAT THE POLICIES OF INSURANCE LISTED BELOW HAVE BEEN ISSUED TO THE INSURED NAMED ABOVE FOR THE POLICY PERIOD INDICATED. NOTWITHSTANDING ANY REQUIREMENT, TERM OR CONDITION OF ANY CONTRACT OR OTHER DOCUMENT WITH RESPECT TO WHICH THIS CERTIFICATE MAY BE ISSUED OR MAY PERTAIN, THE INSURANCE AFFORDED BY THE POLICIES DESCRIBED HEREIN IS SUBJECT TO ALL THE TERMS, EXCLUSIONS AND CONDITIONS OF SUCH POLICIES. LIMITS SHOWN MAY HAVE BEEN REDUCED BY PAID CLAIMS.

INSR LTR	TYPE OF INSURANCE	ADDL INSR	SUBR WVD	POLICY NUMBER	POLICY EFF (MM/DD/YYYY)	POLICY EXP (MM/DD/YYYY)	LIMITS
A	<b>GENERAL LIABILITY</b> <input checked="" type="checkbox"/> COMMERCIAL GENERAL LIABILITY <input type="checkbox"/> CLAIMS-MADE <input checked="" type="checkbox"/> OCCUR  GEN'L AGGREGATE LIMIT APPLIES PER: <input checked="" type="checkbox"/> POLICY <input type="checkbox"/> PRO-JECT <input type="checkbox"/> LOC			39893	11/22/2014	11/22/2015	EACH OCCURRENCE \$1,000,000 DAMAGE TO RENTED PREMISES (Ea occurrence) \$100,000 MED EXP (Any one person) \$5,000 PERSONAL & ADV INJURY \$1,000,000 GENERAL AGGREGATE \$2,000,000 PRODUCTS - COMP/OP AGG \$1,000,000 \$
	<b>AUTOMOBILE LIABILITY</b> <input type="checkbox"/> ANY AUTO <input type="checkbox"/> ALL OWNED AUTOS <input type="checkbox"/> HIRED AUTOS <input type="checkbox"/> SCHEDULED AUTOS <input type="checkbox"/> NON-OWNED AUTOS						COMBINED SINGLE LIMIT (Ea accident) \$ BODILY INJURY (Per person) \$ BODILY INJURY (Per accident) \$ PROPERTY DAMAGE (Per accident) \$ \$
	<input type="checkbox"/> UMBRELLA LIAB <input type="checkbox"/> EXCESS LIAB <input type="checkbox"/> DED <input type="checkbox"/> RETENTION \$						<input type="checkbox"/> OCCUR <input type="checkbox"/> CLAIMS-MADE EACH OCCURRENCE \$ AGGREGATE \$ \$
	<b>WORKERS COMPENSATION AND EMPLOYERS' LIABILITY</b> ANY PROPRIETOR/PARTNER/EXECUTIVE OFFICER/MEMBER EXCLUDED? (Mandatory in NH) If yes, describe under DESCRIPTION OF OPERATIONS below						<input type="checkbox"/> Y <input checked="" type="checkbox"/> N N/A WC STATUTORY LIMITS OTHER E.L. EACH ACCIDENT \$ E.L. DISEASE - EA EMPLOYEE \$ E.L. DISEASE - POLICY LIMIT \$

DESCRIPTION OF OPERATIONS / LOCATIONS / VEHICLES (Attach ACORD 101, Additional Remarks Schedule, if more space is required)

Tents & Rentals for Events.

<b>CERTIFICATE HOLDER</b>  City of Dania Beach 100 West Dania Beach Dania Beach FL 33004	<b>CANCELLATION</b>  SHOULD ANY OF THE ABOVE DESCRIBED POLICIES BE CANCELLED BEFORE THE EXPIRATION DATE THEREOF, NOTICE WILL BE DELIVERED IN ACCORDANCE WITH THE POLICY PROVISIONS.  <b>AUTHORIZED REPRESENTATIVE</b> 
--	---



# CERTIFICATE OF LIABILITY INSURANCE

DATE (MM/DD/YYYY)

05/05/2015

THIS CERTIFICATE IS ISSUED AS A MATTER OF INFORMATION ONLY AND CONFERS NO RIGHTS UPON THE CERTIFICATE HOLDER. THIS CERTIFICATE DOES NOT AFFIRMATIVELY OR NEGATIVELY AMEND, EXTEND OR ALTER THE COVERAGE AFFORDED BY THE POLICIES BELOW. THIS CERTIFICATE OF INSURANCE DOES NOT CONSTITUTE A CONTRACT BETWEEN THE ISSUING INSURER(S), AUTHORIZED REPRESENTATIVE OR PRODUCER, AND THE CERTIFICATE HOLDER.

IMPORTANT: If the certificate holder is an ADDITIONAL INSURED, the policy(ies) must be endorsed. If SUBROGATION IS WAIVED, subject to the terms and conditions of the policy, certain policies may require an endorsement. A statement on this certificate does not confer rights to the certificate holder in lieu of such endorsement(s).

<b>PRODUCER</b>  Automatic Data Processing Insurance Agency, Inc. 1 Adp Boulevard Roseland, NJ 07068	<b>CONTACT NAME:</b> PHONE (A/C, No., Ext): _____ FAX (A/C, No): _____ E-MAIL ADDRESS: _____	
	<b>INSURER(S) AFFORDING COVERAGE</b>	
<b>INSURED</b>  TENTS N EVENTS, INC. 201 SW 12TH AVE Pompano Beach, FL 33069	<b>INSURER A:</b> Technology Insurance Company, Inc.	<b>NAIC #</b> 42376
	<b>INSURER B:</b>	
	<b>INSURER C:</b>	
	<b>INSURER D:</b>	
	<b>INSURER E:</b>	
	<b>INSURER F:</b>	

**COVERAGES**

CERTIFICATE NUMBER: 340183

REVISION NUMBER:

THIS IS TO CERTIFY THAT THE POLICIES OF INSURANCE LISTED BELOW HAVE BEEN ISSUED TO THE INSURED NAMED ABOVE FOR THE POLICY PERIOD INDICATED. NOTWITHSTANDING ANY REQUIREMENT, TERM OR CONDITION OF ANY CONTRACT OR OTHER DOCUMENT WITH RESPECT TO WHICH THIS CERTIFICATE MAY BE ISSUED OR MAY PERTAIN, THE INSURANCE AFFORDED BY THE POLICIES DESCRIBED HEREIN IS SUBJECT TO ALL THE TERMS, EXCLUSIONS AND CONDITIONS OF SUCH POLICIES. LIMITS SHOWN MAY HAVE BEEN REDUCED BY PAID CLAIMS.

INSR LTR	TYPE OF INSURANCE	ADDL INSD	SUBR VVD	POLICY NUMBER	POLICY EFF (MM/DD/YYYY)	POLICY EXP (MM/DD/YYYY)	LIMITS
	<b>COMMERCIAL GENERAL LIABILITY</b> <input type="checkbox"/> CLAIMS-MADE <input type="checkbox"/> OCCUR  GEN'L AGGREGATE LIMIT APPLIES PER: <input type="checkbox"/> POLICY <input type="checkbox"/> PRO-JECT <input type="checkbox"/> LOC OTHER: _____						EACH OCCURRENCE \$ DAMAGE TO RENTED PREMISES (Ea occurrence) \$ MED EXP (Any one person) \$ PERSONAL & ADV INJURY \$ GENERAL AGGREGATE \$ PRODUCTS - COM/PROP AGG \$ \$
	<b>AUTOMOBILE LIABILITY</b> <input type="checkbox"/> ANY AUTO <input type="checkbox"/> ALL OWNED AUTOS <input type="checkbox"/> HIRED AUTOS <input type="checkbox"/> SCHEDULED AUTOS <input type="checkbox"/> NON-OWNED AUTOS						COMBINED SINGLE LIMIT (Ea accident) \$ BODILY INJURY (Per person) \$ BODILY INJURY (Per accident) \$ PROPERTY DAMAGE (Per accident) \$ \$
	<b>UMBRELLA LIAB</b> <input type="checkbox"/> OCCUR <b>EXCESS LIAB</b> <input type="checkbox"/> CLAIMS-MADE DED _____ RETENTION \$ _____						EACH OCCURRENCE \$ AGGREGATE \$ \$
A	<b>WORKERS COMPENSATION AND EMPLOYERS' LIABILITY</b> ANY PROPRIETOR/PARTNER/EXECUTIVE OFFICER/MEMBER EXCLUDED? (Mandatory in NH) If yes, describe under DESCRIPTION OF OPERATIONS below	Y/N	Y/N	TWC3454022	12/31/2014	12/31/2015	<input checked="" type="checkbox"/> PER STATUTE <input type="checkbox"/> OTH-ER E.L. EACH ACCIDENT \$ 100,000 E.L. DISEASE - EA EMPLOYEE \$ 100,000 E.L. DISEASE - POLICY LIMIT \$ 500,000

DESCRIPTION OF OPERATIONS / LOCATIONS / VEHICLES (ACORD 101, Additional Remarks Schedule, may be attached if more space is required)

**CERTIFICATE HOLDER****CANCELLATION**

City of Dania Beach  
 100 W. Dania Beach Blvd  
 Dania Beach, FL 33004

SHOULD ANY OF THE ABOVE DESCRIBED POLICIES BE CANCELLED BEFORE THE EXPIRATION DATE THEREOF, NOTICE WILL BE DELIVERED IN ACCORDANCE WITH THE POLICY PROVISIONS.

AUTHORIZED REPRESENTATIVE

*Mandy H. Munn*

EXISTING PARKING

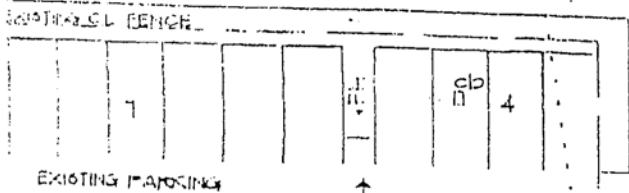

Fire Hydrant

(3) 5 Ton A/C Units

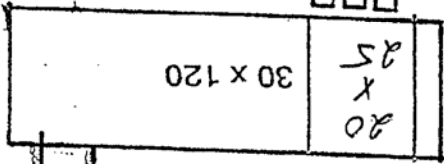

9 x 45

Neptune Fireworks  
 768 E Dania Beach Blvd  
 Dania Beach, Florida

Firework Sales  
 9 AM - 9 PM

EXISTING ASPHALT PAVEMENT

EXISTING PARKING

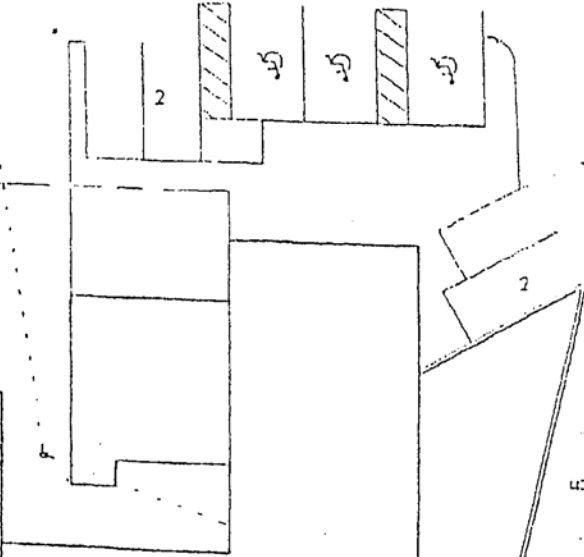

EXISTING SIGN

EXISTING PARKING

EXISTING ASPHALT PAVEMENT

EXISTING ASPHALT PAVEMENT

EXISTING PARKING

BLANK PIPE

Lighthouse

Canopy will be used for coverage  
 white customers stand in line.  
 Restrooms located inside store

DANIA BEACH BLVD

NO COOKING

Electrical Plans:

○ (5) Hi-Lid Lights powered by extension cords using on site electrical outlets 400 watt bulbs each light

□ Exit Lights powered by extension cords using on site electrical outlets

□ (3) 5 Ton Air Conditioning Units using on site electrical outlets

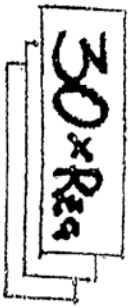

Legend:

⊘ No Smoking Signs

□ Emergency Lit Exit Signs

☀ Fire Extinguisher

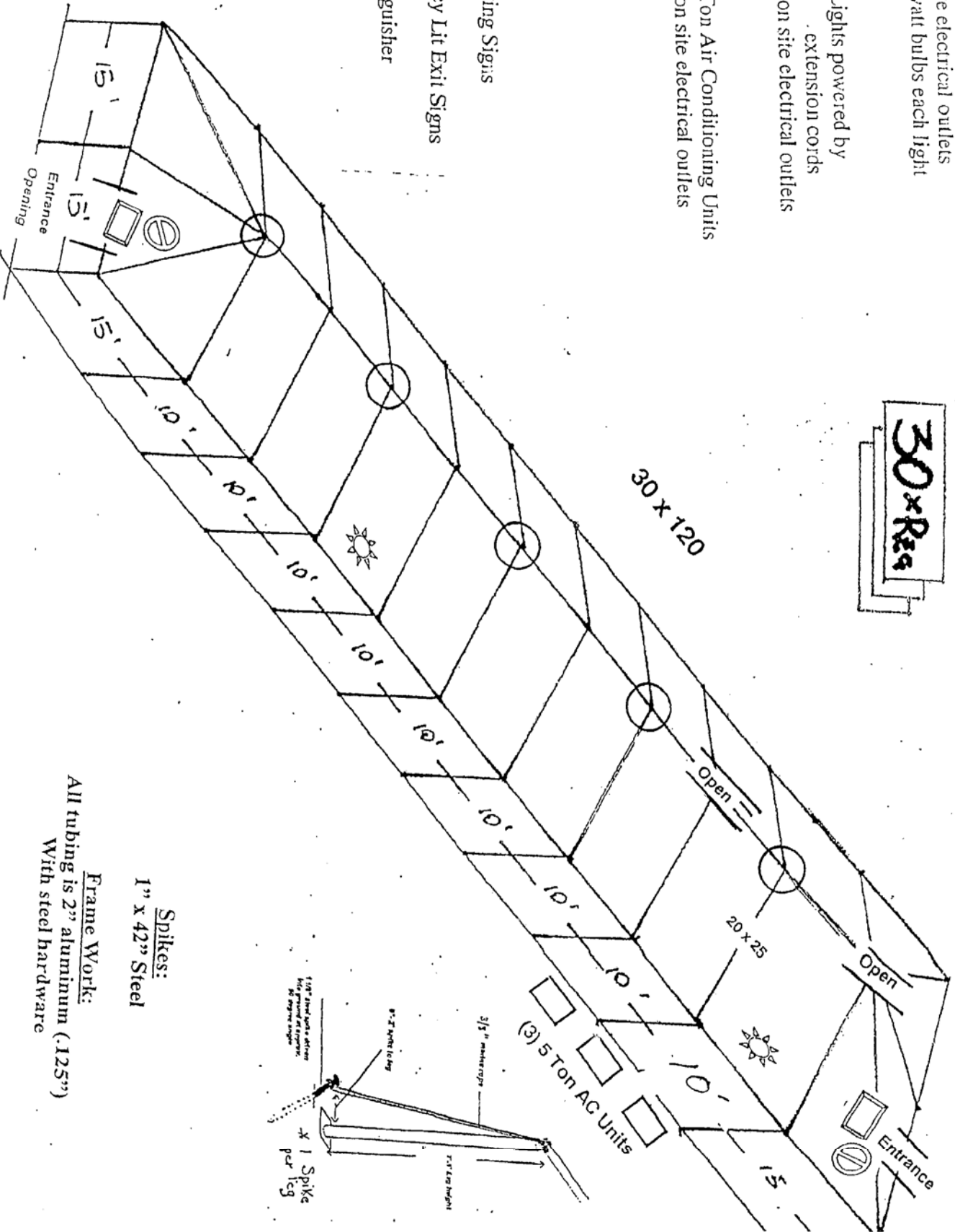

Street Side

Spikes:  
1" x 42" Steel

Frame Work:  
All tubing is 2" aluminum (.125")  
With steel hardware

# ATTACH GUARD BEFORE USING TEMPORARY LIGHT

IN ORDER TO COMPLY WITH REQUIREMENT NO. 1088 ALL LIGHT STRINGS MUST BE USED WITH ONE OF THE GUARDS LISTED BELOW.

## STYLE #1 - METAL

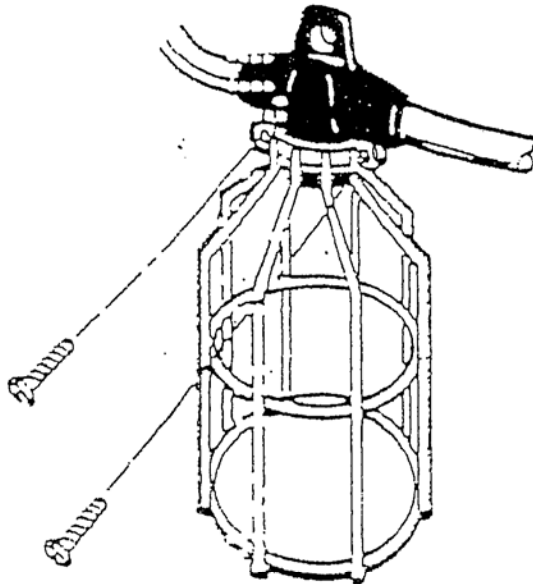

C-0397-000-BL (Vinyl coated metal guard)

TO ASSEMBLE: Push guard onto temporary light then secure with machine screws.

(2 Req'd.)  
#8-32 x 5/8  
Machine Screws

**CONTRACTOR'S  
COPY**

## STYLE #2 - PLASTIC

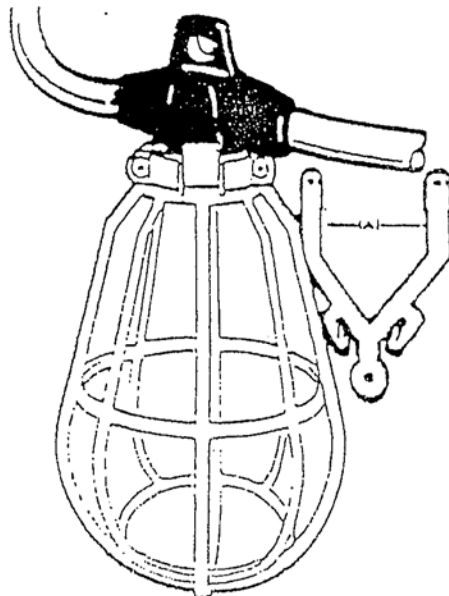

C-0348-000-YW

TO ASSEMBLE: Remove and discard plastic hanger (A) from guard. Fasten guard to temporary light then secure with tapping screws.

NOTE: Plastic Hanger (A) for use on Economy Light String  
Cat. No. A-2253-101-00 only.

(2 Req'd.)  
#8-1/2  
Tapping Screws

  
**ELECTRICORD**  
A LEVITCH COMPANY

PACIFIC ELECTRICORD COMPANY  
247 W. Redwood Basin Blvd. • P.O. Box 10 • Gardena, CA 90247  
Telephone (310) 522-6600 • (800) 226-1017 • Fax (310) 522-6044

Tents N Events  
1790 Mears Parkway  
Margate, FL 33063

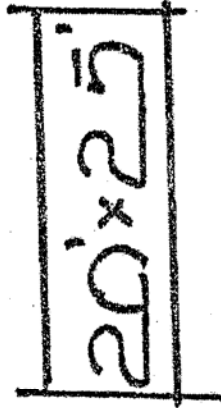
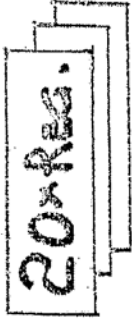

Time Downs:  
1" x 42" Steel Spikes  
3/8" Marine Poly Rope

No Cooking

Electrical Plans: ○

(1) Hi-Lid Light powered by extensions cords using on site electrical outlets / 400 Watt Bulbs

Frame Work:  
All tubing is 2" aluminum (.125")  
With steel hardware

Legend  
☀ Fire Extinguisher  
☐ Exits - Lit Emergency Signs

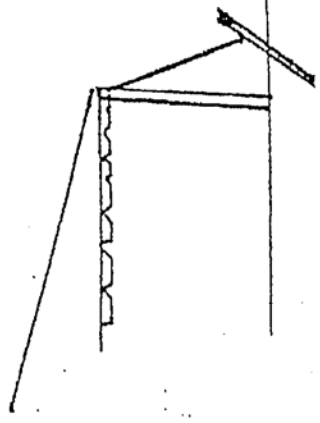
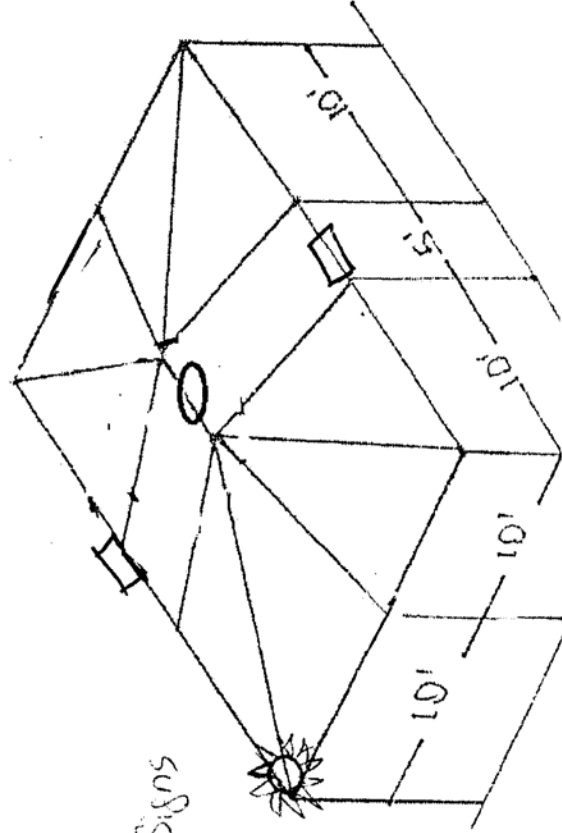

Tents N Events, Inc.  
 A Tent for every event  
 1790 Mears Pkwy.  
 Margate FL 33063

9' x 45'

9' x 45'

Legend:



No Smoking Signs



Emergency Lit Exit Signs



Fire Extinguisher

Electrical Plans:

Caged lights will be provided powered by  
 60 Watt Light bulbs

: extension cords

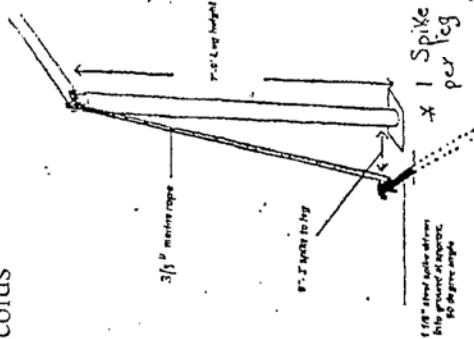
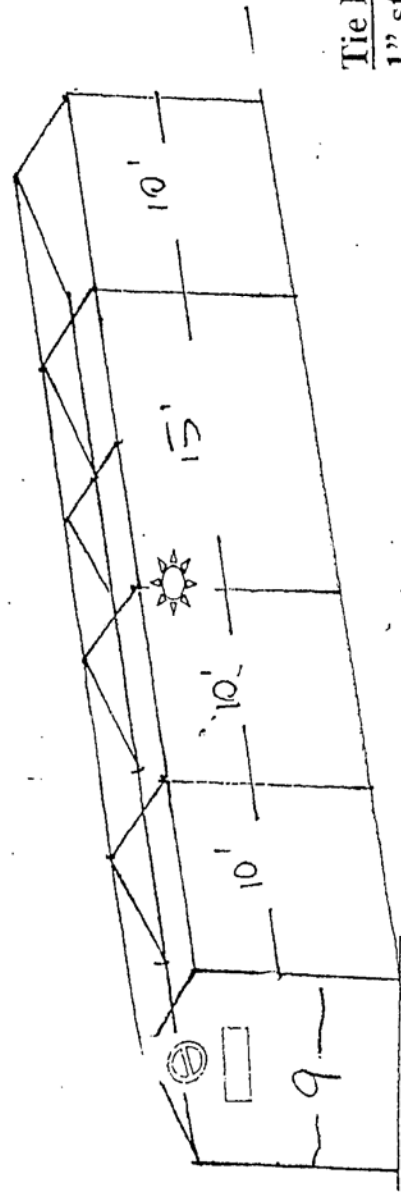

Tie Downs:

1" steel spikes 40" long  
 3/8" poly marine rope

Frame Work:

All tubing is 2" aluminum (.125)  
 With steel hardware ID 1.35 OD 1.73



# 16" Aluminum (400 Watt High Bay Light, Pulse Start Metal Halide, 120-277v)

- Lamp:400W PSMH
- Input Watts:458
- Voltage:120-277V
- Base:Mogul Open Rated
- ANSI:M155/O
- Start Up Time:3-5 mins
- Lumen Output:41,000
- Lamp Life:20,000
- Width:16"
- Height:24.5"

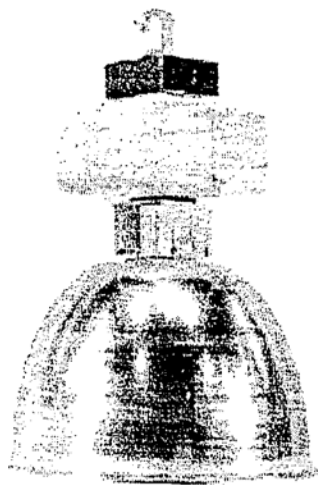

## Specifications

- Sturdy die-cast aluminum housing
- Adjustable lamp position
- Rugged 4kv porcelain open rated socket
- Wiring compartment with adjustable leveling feature
- 16-inch spun aluminum reflector
- Mount using threaded 3/4-in conduit or with hook & cord accessory kit
- Maximum ambient temperature of 35 degrees C
- UL Listed in U.S. for damp locations